

MC65

Quick Start Guide

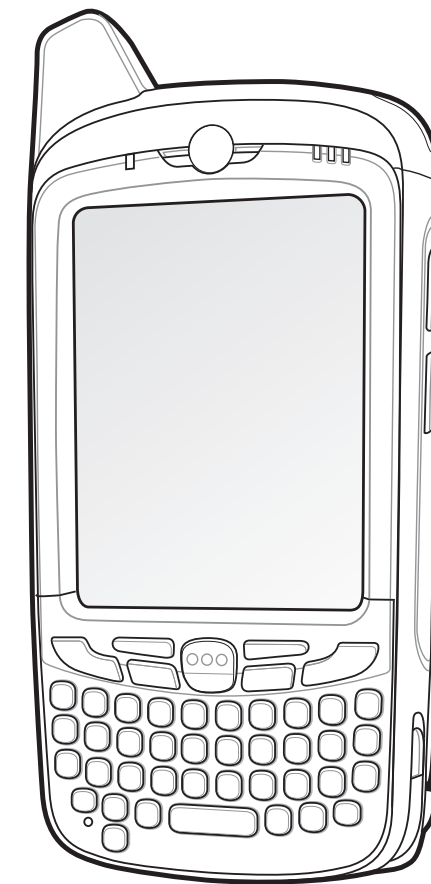

FEATURES

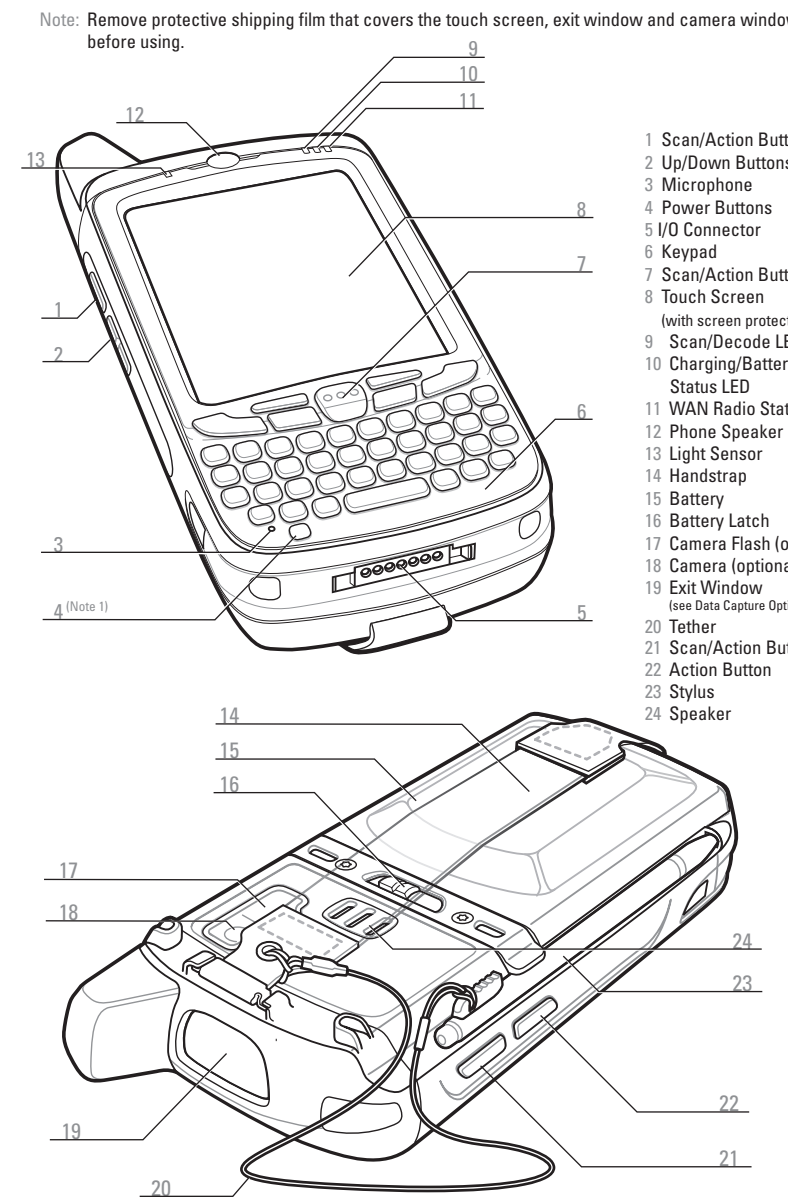

- 1 Scan/Action Button
- 2 Up/Down Buttons
- 3 Microphone
- 4 Power Buttons
- 5 I/O Connector
- 6 Keypad
- 7 Scan/Action Button
- 8 Touch Screen (with screen protector)
- 9 Scan/Decode LED
- 10 Charging/Battery Status LED
- 11 WAN Radio Status LED
- 12 Phone Speaker
- 13 Light Sensor
- 14 Handstrap
- 15 Battery
- 16 Battery Latch
- 17 Camera Flash (optional)
- 18 Camera (optional)
- 19 Exit Window (see Data Capture Options)
- 20 Tether
- 21 Scan/Action Button
- 22 Action Button
- 23 Stylus
- 24 Speaker

Note 1: To reset the MC65, simultaneously press the 1 key, 9 key and Power button.

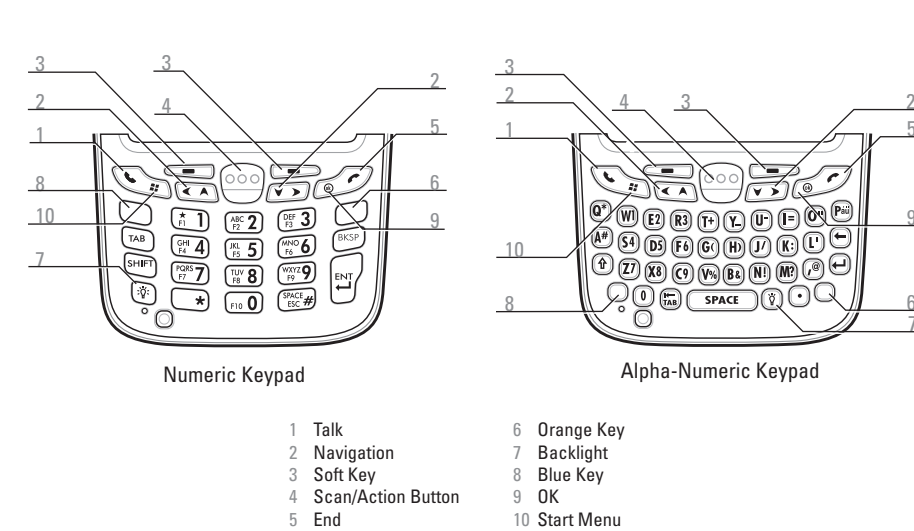

Blue Key

Use this key to access function keys shown on the keypad in blue.

- > Press the Blue key once to activate this state, followed by another key.

Orange Key

Use this key to access the secondary layer of characters.

- > Press the Orange key once to lock the keypad into Alpha state.
- > Press the Orange key a second time to return to the normal state.

Notifications

Data Capture LED:

- Red: Scanning active
- Green: Good Decode
- Message Notification

Charging/Battery Status LED:

- Slow blinking amber: Battery charging
- Solid amber: Fully charged
- Fast blinking amber: Charging error

WAN Radio Status LED:

- Green: RF active

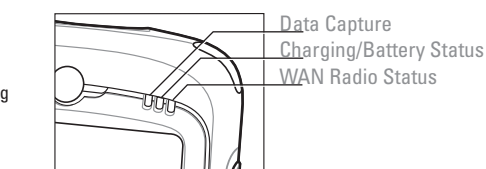

GETTING STARTED

MicroSD Card Installation (Optional)

1. Remove the handstrap.
2. Lift the rubber access door.
3. Slide the SIM card holder up to unlock.
4. Lift the SIM card holder.
5. Carefully lift the microSD card holder.
6. Insert the microSD card into the card holder.

NOTE:

Proper position of the microSD card — the card connector (i.e., gold contacts) should be facing out as shown.

7. Gently lower the microSD card holder until it snaps into place.

SIM Card Installation (Optional)

8. Insert the SIM card into the SIM holder.

NOTE:

The proper position of the SIM card—the card connector (i.e., gold area) should be facing outward with the beveled corner facing away.

9. Lower the SIM card holder.
10. Slide the SIM card holder down to lock into place.
11. Close the rubber access door.
12. Install the battery.

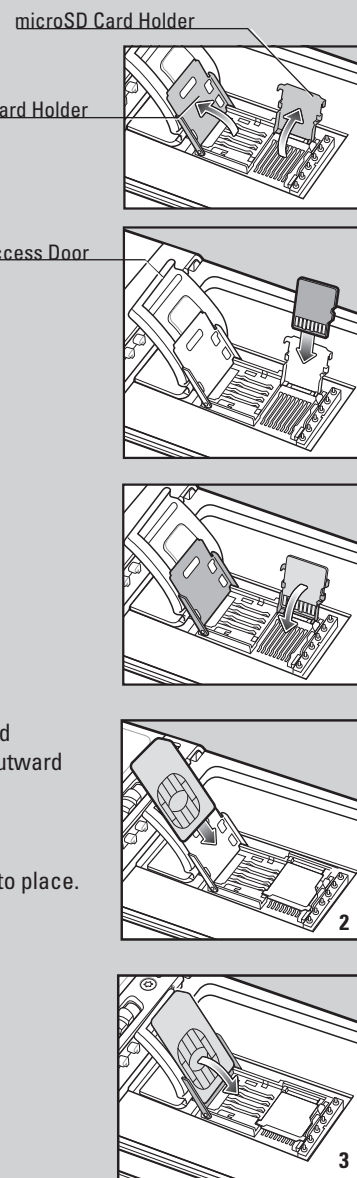

BATTERY INSTALLATION

Install the Battery

1. Insert the battery, bottom first, into the battery compartment.
2. Press down on the battery until the battery latch snaps into place.
3. Replace the handstrap.

Remove the Battery

1. Press and hold the Power button for approximately 10 seconds.
2. Release the Power button. The Data Capture LED lights red.
3. When the LED turns off, remove the handstrap.
4. Slide the battery latch to the right. The battery ejects slightly.
5. Grasp the battery and lift from the MC65.

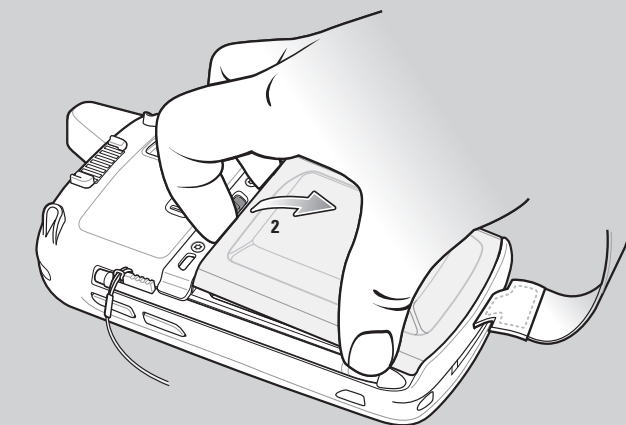

CHARGING

Charge the MC65

Before using the MC65, ensure that the battery is fully charged.

Use the Single-slot USB cradle, or Four-slot cradles (Charge Only or Ethernet) to charge the battery in the MC65.

You can also use the Charge Only and USB/Charging cables to charge the MC65.

Charge a spare battery using the Single-slot cradle.

- Charging/Battery Status LED
- Slow Blinking Amber = Charging
- Solid Amber = Fully charged
- Fast Blinking Amber = Charging error

Charge the Battery

Use the Four-slot Battery Charger to charge batteries separately.

Note: The 3600 mAh battery charges in less than six hours.

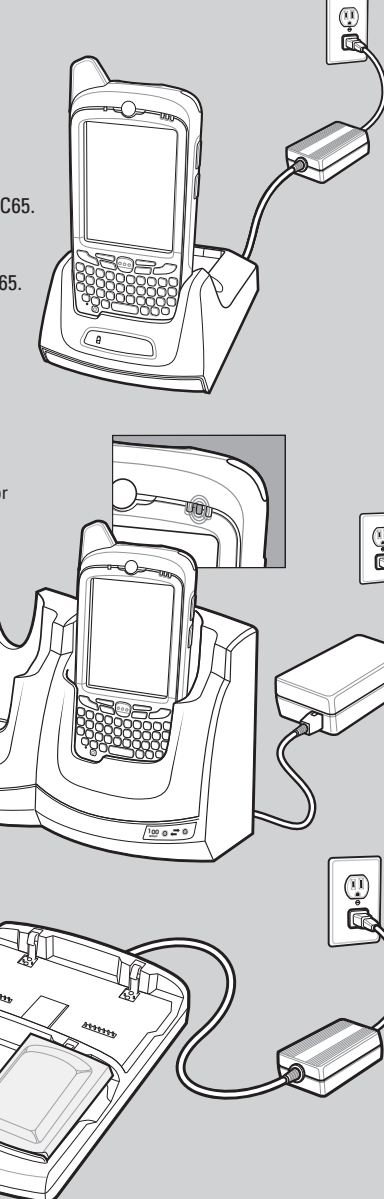

PHONE SETUP/ACTIVATION

GSM/UMTS Activation

Press the Power button to turn on the MC65.

If a SIM card from a supported carrier is installed, the MC65 detects the installed activated SIM card and activates on the GSM/UMTS network and configures the data connections.

If a SIM card from an unsupported carrier is installed, the MC65 detects the installed activated SIM card and activates on the GSM/UMTS network, but the data connection and the MMS connection information must be manually configured.

Refer to the *MC65 Integrator Guide* for more information.

CDMA Activation

To activate the MC65 on a CDMA network:

1. Press the Power button to turn on the MC65.
2. Tap **Start** > **Settings** > **Connections** > **Phone Network Setup**.
3. On the **CDMA** tab, select a carrier from the preferred network option.
4. Tap the **Start Activation** button.
5. Tap **Yes** to activate.
6. Call the carrier from an existing phone to request over-the-air activation.
7. When instructed by the operator press **Activate Now** button.

For detailed information on activating the MC65, refer to the *MC65 Integrator Guide*.

More Information on the MC65

Visit the Zebra Web site at <http://www.zebra.com/MC65>

Setting up, using and troubleshooting the MC65

MC65 User Guide and Integrator Guide

Software Upgrades

Available at: <http://www.zebra.com/support>

Additional Software

Check Zebra web site for approved applications.

<http://www.zebra.com/MC65>

Connecting and synchronizing with the host computer

ActiveSync® Help on the host computer. To view help, start ActiveSync®,

Click Help - Microsoft ActiveSync Help.

ActiveSync software available at <http://www.microsoft.com/windowsmobile>

Information on using programs on the MC65

Tap **Start** – **Help** within the specific program.

Service and Warranty

MC65 Regulatory Guide

Available with MC65 and at <http://www.zebra.com/support>



Zebra Technologies Corporation
Lincolnshire, IL U.S.A.

Zebra and the Zebra head graphic are registered trademarks of ZIH Corp.
The Symbol logo is a registered trademark of Symbol Technologies, Inc., a Zebra Technologies company. All other trademarks are the property of their respective owners.
© 2015 Symbol Technologies Inc.



72-134041-02 Rev. A — February 2015

COMMUNICATION

Install ActiveSync®

Download ActiveSync® 4.5 or higher from <http://www.microsoft.com> and follow the instructions to install ActiveSync onto the host computer.

Communicate with Host

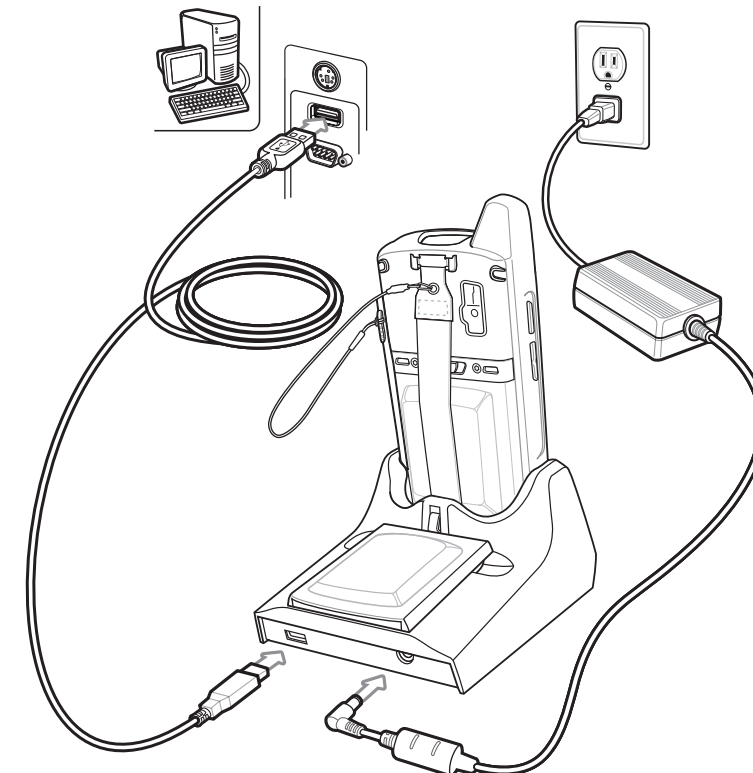

Create a Partnership

Follow the on-screen ActiveSync instructions to establish a connection between the MC65 and the host computer.

<http://www.zebra.com/MC65>

ACCESSORIES

Screen Protector

Zebra recommends the continued use of a screen protector to minimize wear and tear. Screen protectors enhance the usability and durability of touch screen displays. Benefits include:

- Protection from scratches and gouges
- Durable writing and touch surface with tactile feel
- Abrasion and chemical resistance
- Glare reduction
- Keeping the device's screen looking like new
- Quick and easy installation.

Not using a screen protector can affect your warranty coverage.

An initial screen protector is already applied to your MC65.

Contact your local account manager or Zebra for more information

and purchasing details. Part number: KT-67525-01R Screen Protector 3/pk.

Four-slot Charge Only Cradle

Four-slot Ethernet Cradle

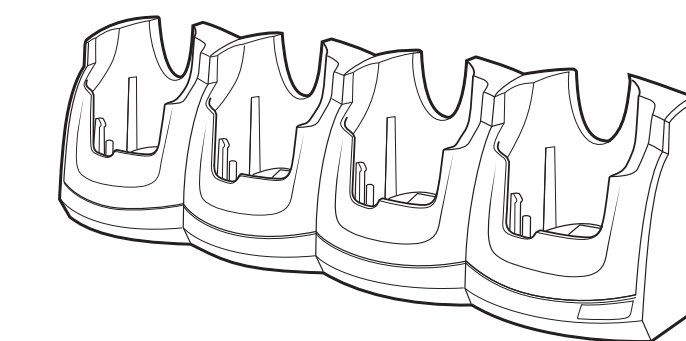

Four-slot Battery Charger Charge Only Cable USB/Charge Cable

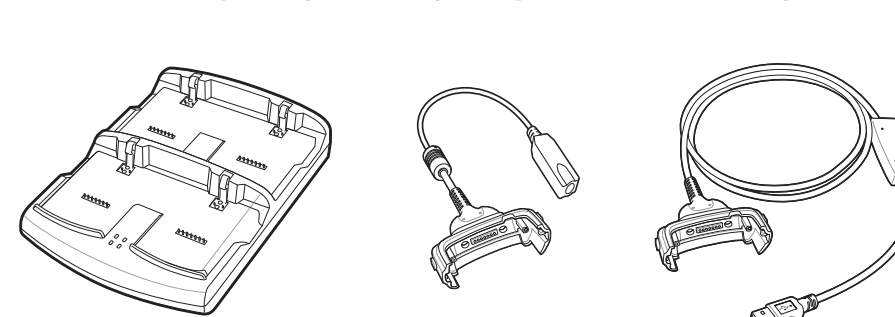

Magnetic Stripe Reader

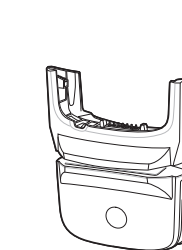

Single-slot USB Cradle

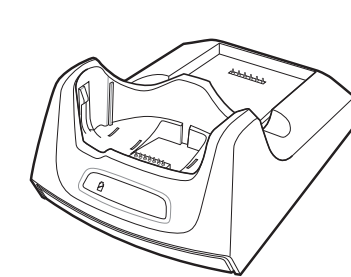

Vehicle Cradle

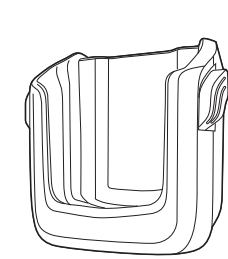

Trigger Handle

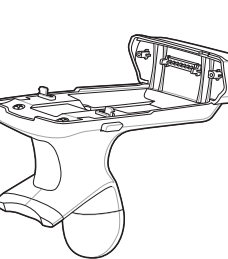

Auto Charge Cable

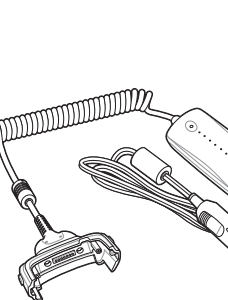

Vehicle Holder

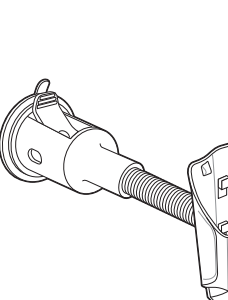

DATA CAPTURE OPTIONS

Imaging

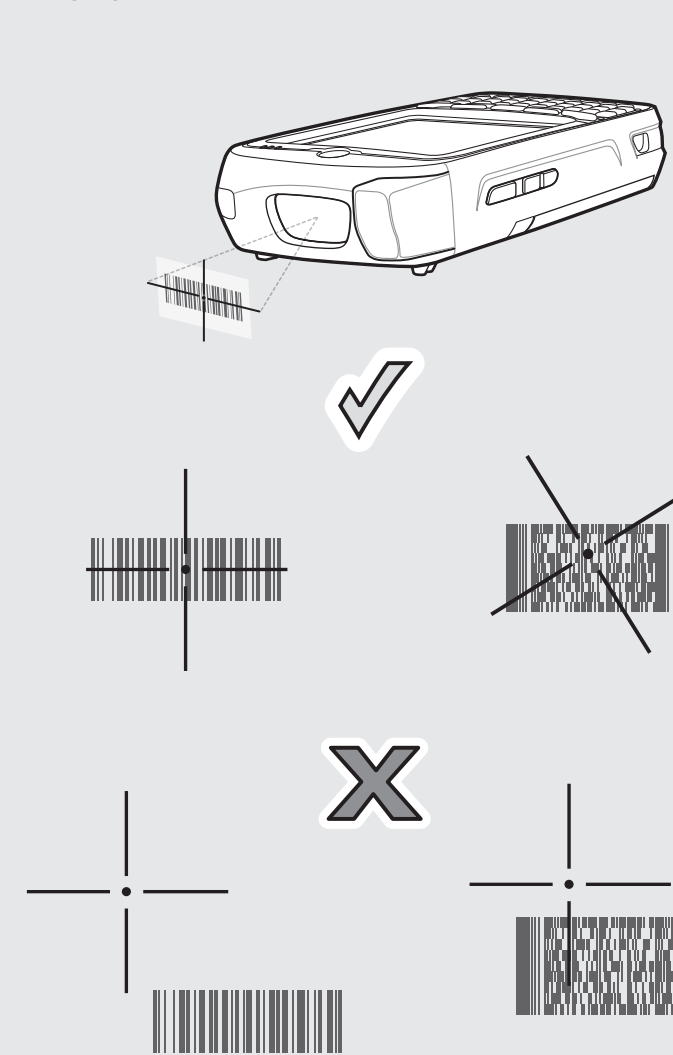

Camera Decode

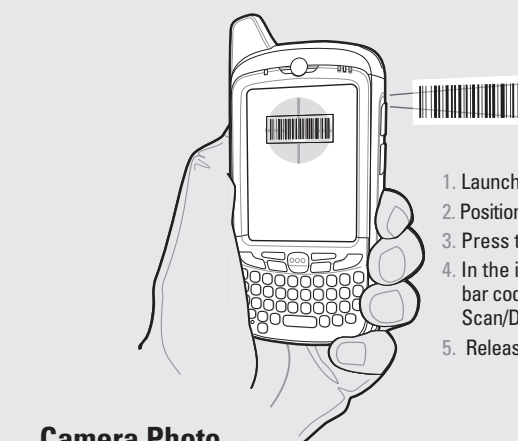

1. Launch a bar code reading application on the MC65.
2. Position the MC65 toward the bar code.
3. Press the **Scan** button.
4. In the image window align the red target over the bar code. When the MC65 decodes the bar code the Scan/Decode LED light green and a beep sounds.
5. Release the **Scan** button.

Camera Photo

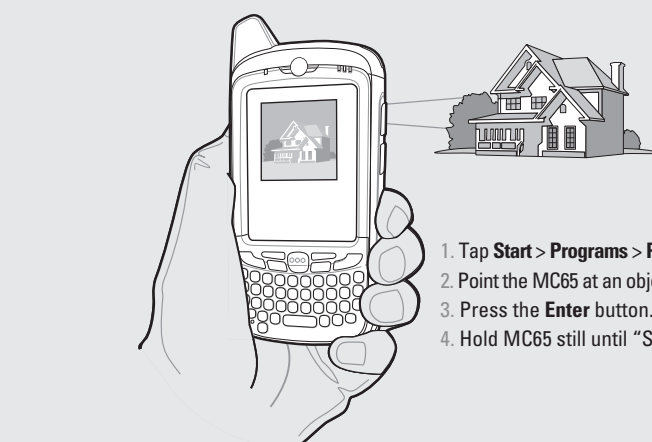

1. Tap **Start** > **Programs** > **Pictures & Videos** > **Camera**.
2. Point the MC65 at an object.
3. Press the **Enter** button.
4. Hold MC65 still until "Shutter Sound" is heard.

GPS Information

- When using the GPS feature of the MC65:
- Acquiring satellite signals may take a few minutes. It is best to be outside and have a clear, unobstructed view of the sky.
 - Without a clear view, acquisition takes much longer and could result in the MC65 being unable to compute the initial position quickly.
 - Obtain a satellite fix before moving.
 - Shutdown GPS application when not in use.

AVOID EXTREME WRIST ANGLES

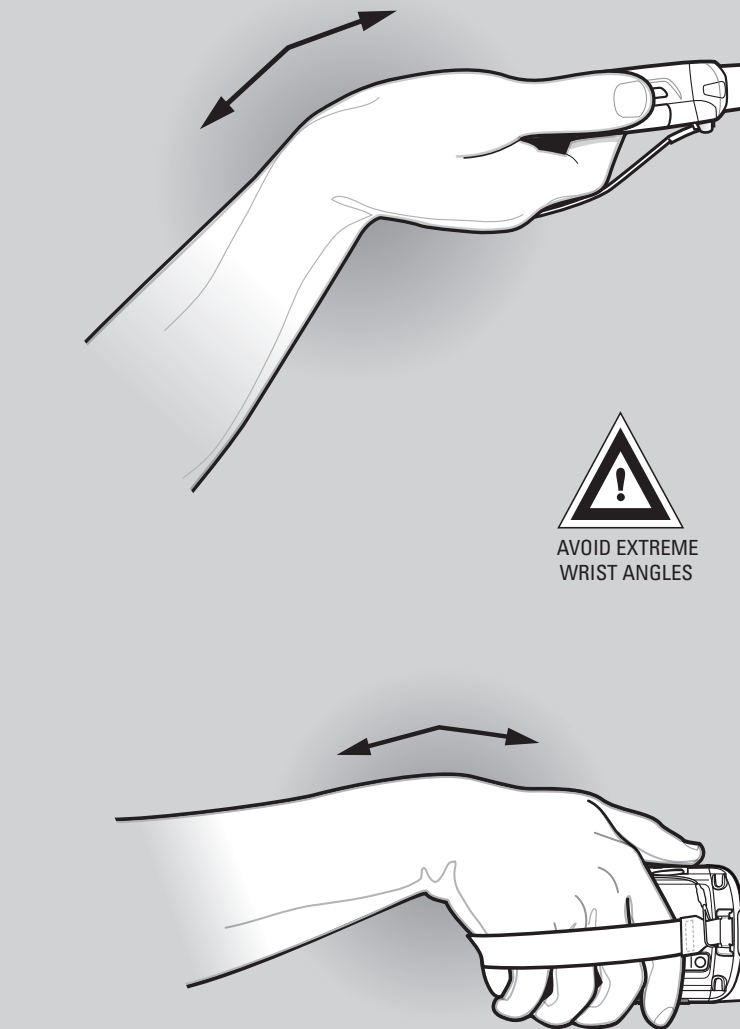

AVOID EXTREME WRIST ANGLES